

SPAR-Austria Logistics Handbook for Supplier

Assortment: Ambient Goods and Non-Food

Version: January 2024

History of changes

Version	Changes	Page
January 2024	Changed goods arrival times ZN01 Changed contact information	Page 6 Page 4& 6
October 2023	Changed goods arrival times	Page 12
September 2023	Changed contact information Changed contact information Handeling of reusable packaging Placing of pallet-label	Page 7 Page 22 Page 24 Page 28

Table of Contents:

1. [New Suppliers](#)
2. [Delivery Process in all SPAR Warehouses](#)
 - [2.1 Details Warehouse Dornbirn](#)
 - [2.2 Details Warehouse - Wörgl](#)
 - [2.3 Details Warehouse - Marchtrenk](#)
 - [2.4 Details Warehouse – St. Pölten](#)
 - [2.5 Details Warehouse – Ebergassing](#)
 - [2.6. Details Warehouse – Graz](#)
 - [2.7 Details Warehouse – Maria Saal](#)
3. [Conditions for Delivery Processing](#)
 - [3.1 Loading Aids](#)
 - [3.2 Pallet Quality](#)
 - [3.3 Pallet Goods-Shifting](#)
 - [3.4 Pallet Heights](#)
 - [3.5 Pallet Weight](#)
 - [3.6 Condition of the pallet](#)
 - [3.7 Condition of the picking unit](#)
 - [3.8 Delivery note](#)
 - [3.9 ¼ Displays and Dollys](#)
 - [3.10 Dangerous Substances](#)
 - [3.11 Delivery in Reuseable Cases](#)
4. [Labelling](#)
 - [4.1 Pallet Labelling](#)
 - [4.2 Examples of Delivery Notes \(DIN A5\)](#)
 - [4.3 Placement of the pallet labels](#)
 - [4.4 WPU \(Wholesale -Packing-Unit\)](#)
 - [4.5 RPU \(Retail Packing Unit\)](#)
 - [4.6 Barcode quality](#)
5. [Electronic Data Interchange with SPAR](#)
6. [Safety measurements at Goods Receiving](#)

1. New Suppliers

- In order to avoid any problems in advance, please contact the Logistics Department prior to the first delivery.
- Contact:
 - SPAR Österr. Warenhandels AG, Salzburg, Europastr. 3, A-5015 Salzburg:
 - Fabian Eßl, MA
 - Tel.: +43 664 8874 8668
 - E-Mail: fabian.essl@spar.at
- Additionally, the registration on our B2B Portal is necessary (<http://b2b.spar.at>). There you also always find the latest version of our logistics handbook.

Delivery Process in all SPAR Warehouses

Goods Arrival:

The goods arrival can occur by truck in all SPAR Warehouses. The goods arrival by bus, car or any other small vehicle is not allowed and will lead to a rejection of the delivery.

Standard Delivery Condition for all regional Warehouses:

Delivery by truck behind first free lockable door or if existing onto the free conveyor equipment (Furthermore the SPAR Company general terms of delivery apply). For the unloading of the goods the suppliers will be supplied with manual pallet lifters, electrical pallet lifters and double-pallet fork-lift trucks.

Punctuality of Deliveries:

All delivery dates, which are agreed with SPAR, must be met. Trucks, which arrive on the wrong date, can be rejected by the goods arrival.

In order to guarantee a punctual unloading at the SPAR warehouses and to avoid stand by times, there is the possibility of time slot reservation with MERCAREON time slot management. Via the MERCAREON internet portal delivering carriers have the possibility to view the available time slots for a specific delivery and to book the most adequate slot. Please find more information at www.mercareon.com.

2.1 Details Warehouse Dornbirn

SPAR Österr. Warenhandels AG, Dornbirn

Delivery Area	Vorarlberg
Address	Wallenmahd 46, A-6850 Dornbirn
GLN	91 00010 00000 5
Acronym	ZN 01

Contact-Information

Name	Phone-Number	E-Mail
Sabrina Eibl	+43 5572 309 31591	sabrina.eibl@spar.at



Goods Arrival Times – Ambient Goods

Monday-Thursday	05:00-13:00
Friday	05:00-10:00
Saturday-Sunday	Closed



2.2 Details Warehouse - Wörgl

SPAR Österr. Warenhandels AG, Wörgl

Delivery Area	Tirol und Salzburg
Address	SPAR-Straße 1, A-6300 Wörgl
GLN	91 00020 00000 2
Acronym	ZN 02

Contact-Information

Name	Phone-Number	E-Mail
Yvonne Hager	+43 664 88984878	Yvonne.HAGER@spar.at



Goods Arrival Times – Ambient Goods

Mondy-Thursday	06:00-15:00
Friday	06:00-11:00
Saturday-Sunday	Closed

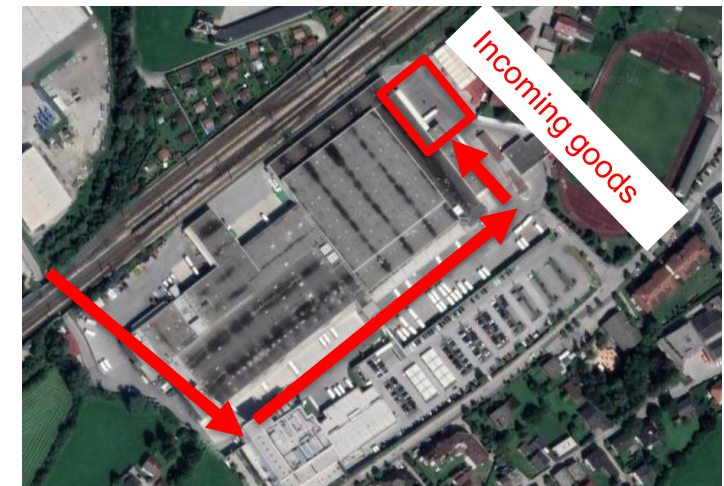

2.3 Details Warehouse - Marchtrenk

SPAR Österr. Warenhandels AG, Marchtrenk

Delivery Area	Oberösterreich
Address	Sparstraße 1, A-4614 Marchtrenk
GLN	91 00030 00000 9
Acronym	ZN 03

Contact-Information

Name	Phone-Number	E-Mail
Lukas Greifeneder	+43 7243 551 33501	lukas.greifeneder@spar.at



Goods Arrival Times – Ambient Goods

Monday-Thursday	06:00-15:00
Friday	06:00-12:00
Saturday-Sunday	Closed



2.4 Details Warehouse – St. Pölten

SPAR Österr. Warenhandels AG, St. Pölten

Delivery Area	Niederösterreich, Wien, nördliches Burgenland
Address	Lagergasse 30, A-3100 St. Pölten
GLN	91 00040 00000 6
Acronym	ZN 04N

Contact-Information

Name	Phone-Number	E-Mail
Thomas Gessner	+43 2742 866 345325	thomas.gessner@spar.at



Goods Arrival Times – Ambient Goods

Monday-Thursday	05:30-14:30
Friday	05:30-11:30
Saturday-Sunday	Closed



2.5 Details Warehouse – Ebergassing

SPAR Österr. Warenhandels AG, Ebergassing

Delivery Area	Wien und northern Burgenland
Address	SPAR Straße 1, A-2435 Ebergassing (Delivery through local area forbidden!)
GLN	91 00041 00000 5
Acronym	ZN 04W

Contact-Information

Name	Phone-Number	E-Mail
Patrick Hörmann	+43 2234 7220030530	Patrick.Hoermann@spar.at



Goods Arrival Times – Ambient Goods

Monday-Friday	11:00-21:00
Saturday-Sunday	Closed



2.6. Details Warehouse – Graz

SPAR Österr. Warenhandels AG, Graz

Delivery Area	Steiermark und südliches Burgenland
Address	Hafner Straße 20, A-8055 Graz (Delivery via Schwarzer Weg!)
GLN	91 00050 00000 3
Acronym	ZN 05

Contact-Information

Name	Phone-Number	E-Mail
Andrea Götschl	+43 316 248 35512	Andrea.goetschl@spar.at



Goods Arrival Times – Ambient Goods

Monday-Thursday	06:00-15:00
Friday	06:00-11:00
Saturday-Sunday	Closed



2.7 Details Warehouse – Maria Saal

SPAR Österr. Warenhandels AG, Maria Saal

Delivery Area	Kärnten und Osttirol
Address	Sparstraße 1. 9063 Maria Saal
GLN	91 00060 00000 0
Acronym	ZN 06

Contact-Information

Name	Phone-Number	E-Mail
Rene Schweighofer	+43 4223 5000 36590	Rene.schweighofer@spar.at



Goods Arrival Times – Ambient Goods



Monday-Thursday	05:00-14:00
Friday	05:00-10:00
Saturday-Sunday	Closed



Conditions for Delivery Processing

3.1 Loading Aids

Accepted loading aids:

CHEP Pallet (B1208A)	Europool Pallet (DIN EN 13698-1)
	
<p>SPAR strongly prefers the use of the CHEP Europallet (B1208A), with the overall dimensions of 1200 mm x 800 mm. In this rental system, no pallet exchange is needed. The empty pallets are collected directly from the regional warehouses by employees of the CHEP company for redistribution.</p>	<p>As a further loading aid SPAR accepts the Europool Pallet (DIN EN 13698-1). They are processed as described below (pallet and poolcase processing).*</p>

SPAR does not accept other loading aids. If the loading aid does not comply with the above-mentioned loading aid, SPAR will charge the supplier for the costs incurred for changing the loading aid (EUR 20.- per pallet).

* Exceptions:

- No exchange for single use, oversea Düsseldorfer pallets.
- Should there, in exceptional cases, not be enough empty pallets/poolcases for an exchange with the supplier, SPAR will retain the pallets/poolcases as a gratuitous loan from the supplier. The truck driver will receive a confirmation with which the reclaim can be asserted. Reclaiming pallets/poolcases is possible at any time during the following three months as soon as the !Original! confirmation is produced. This rule is only applicable at the relevant Regional Warehouse – this means that a confirmation from Wörgl cannot be redeemed at St Pölten etc. For reasons of accounting and stock keeping confirmations older than three months can not be redeemed. The possibility to reclaim will expire after three months. Should the exchange not be possible on the part of SPAR, the confirmation will be extended for further three months.

3.2 Pallet Quality

SPAR will not accept or exchange pallets on which:

1. a board is missing, or broken either diagonally or straight across
2. a base or decking is so damaged or splintered that a nail or a screw is projecting
3. a block is missing or broken or so splintered that screws or nails are visible.
4. there is not at least one identification symbol (EUR and pool-keeper logo) on each long side that is legible.
5. the general condition is so bad that the load - bearing capacity is not guaranteed or where the loaded goods could be damaged or soiled.

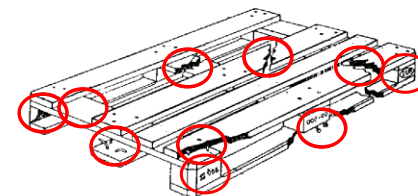

Attention:

An optimal quality of pallets enables an efficient flow of goods in the whole supply chain. In case of a poor pallet quality entry on material-handling equipment is not possible, the risk of breakage is high and goods and in the worst-case consumers can be harmed by wooden splinters, projecting nails and extraordinarily dirty pallets.

Deliveries on poor quality pallets can be rejected by goods receiving, in order to accelerate the goods receiving process.

If the pallets don't meet the SPAR criteria, the supplier will be charged the additional work (EUR 20.- per pallet).

That is also valid for CHEP Pallets, which are distributed over cheaper rental models like the pickup from wholesalers. Such models can lead to a poorer CHEP pallet quality, because of not every pallet being checked and repaired at the CHEP service center. Due to cost and environment reasons this is of course reasonable, but it must not lead to a bad pallet quality. Therefore, every supplier has to check the pallet quality prior to sending, otherwise additional expenses occur in the goods arrival. In case of an accumulation of damaged CHEP pallets we will charge it.

The number of defective pallets and the signature of the goods receiving personnel on the bill of delivery serve as a proof. SPAR has no burden of proof by photographs.

The number of defective pallets and the signature of the goods receiving personnel on the bill of delivery serve as a proof. SPAR has no burden of proof by photographs.

3.3 Pallet Goods-Shifting

No Pallet Shifting Before Transportation

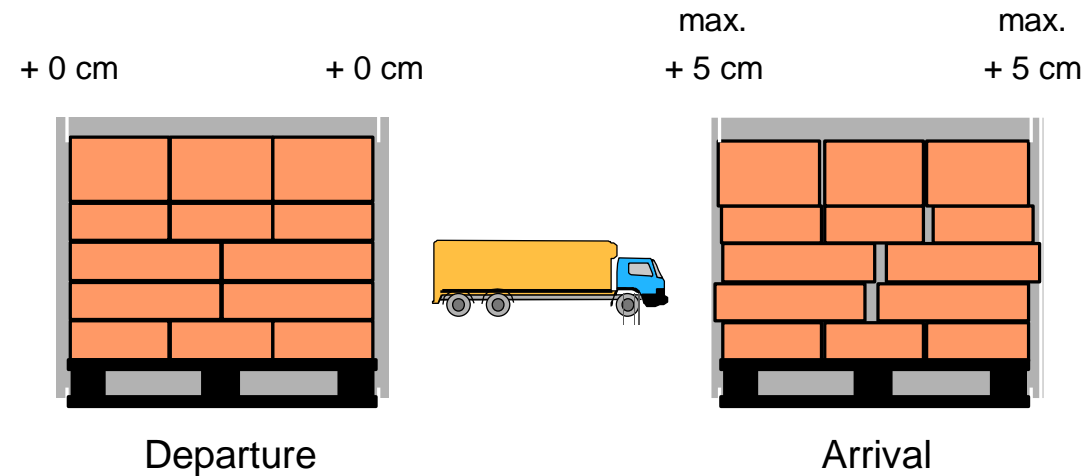

Upon arrival the pallet shifting must not be more than 5cm.

3.4 Pallet Heights

All warehouses are equipped according to EUL pallet heights.

The pallet heights are

ECR-Name	EUL-Overall heights incl. Pallet	
EUL 2	2250 mm	2100 mm product + 150 mm pallet
EUL 1,4	1620 mm	1470 mm product + 150 mm pallet
EUL 1	1200 mm	1050 mm product + 150 mm pallet
EUL ½	675 mm	525 mm product + 150 mm pallet
EUL ⅓	500 mm	350 mm product + 150 mm pallet

3.5 Pallet Weight

The total weight of a pallet may not exceed **1000 kg**.

3.6 Condition of the pallet

- The goods must be stacked as one product per pallet, if the ordered quantity is at least one layer. However, intermediate pallets can be stacked on top of each other.
- Products, in danger of falling off, through transportation by truck, rail or in the warehouse, must be secured with Transport protection (Plastic film or a safety strap). If a plastic film is used, it must not be black.
- All boxes on a pallet must have the same best before date and the same batch number.
- As defined by IFS-Logistics the product safety is a must. That's why a carton must be put between the pallet and goods in easily damageable packaging. This way damaging trough splinters and other sharp items can be avoided and the product safety is guaranteed.

If the condition of the pallet is not conform with the above requirements, SPAR charges the additional expenses of EUR 20,- per pallet.

3.7 Condition of the picking unit

- The goods must be in perfect condition. This means no damaged or soiled goods etc.
- The delivery unit must be a closed, compact unit which permits stacking in any position on our roll cages (the goods must not fall out of the packaging).
- The lid may not detach from the carton when lifting (banderols, glue spots, etc.).
- The barcode must be easily found and may not be attached to the lower side of the unit.
- Heavy goods (especially tin cans and glasses) must be shrinked in foil.
- When Shelf Ready Packaging is applied, the unit should be at least as stable for it to permit efficient handling in the warehouse (Glue to stabilise, banderols etc.).
- The size of the wholesale packaging unit (WPU) should be adjusted to the size of the retail packaging unit in order to prevent damage.
- It is not permitted to pack several WPUs in an overpackaging. One unit must be one move.

If the condition of the picking unit is not conform with the above requirements, SPAR charges the additional expenses of EUR 0,5,- per picking unit.

3.8 Delivery note

- For a proper goods arrival in our warehouses SPAR needs a correct delivery paper (delivery note, CMR), on which the SPAR order number must be quoted. For each SPAR order-number a delivery note must be handed over to the bureau of the goods arrival.
- If the SPAR order number is missing on the delivery note/CMR, the delivery note is missing or just placed on the goods or more than one SPAR order number is quoted on the delivery note, SPAR reserves the right to charge the supplier EUR 25,-. A delivery note isn't necessary, if all relevant information is noted on the CMR.

3.9 ¼ Displays and Dollies

Displays which exceed the weight of 25 kg have to be delivered - without exceptions - on dollies. The handling of such heavy displays (without a dolly) is not possible, neither in our outlets nor in our warehouses – most of the time the displays have to be manoeuvred by hand. A Dolly is a free-wheeling load bearing device which conforms to the European standard norms for Supply Chains in the Fast Moving Consumer Goods sector (i.e. ISO 3394 ff). Dollies have to be wrapped together in a quantity of four with the flexible wheels placed outside and the fixed wheels placed inside (if an appropriate amount is ordered). If a unit of 4 is not possible due to the order quantity, the dollies must be delivered with sufficient transport-security, whereby the delivery on a pallet is forbidden. For each ¼ displays, which exceeds the weight of 25 kg and is delivered without dolly, the supplier will be charged € 10,- per display.



SPAR prefers a crossed application of the banderoles on displays and dollies. Please have at least one banderole per long and broad side. In addition, a cardboard sleeve or tight-fitting plastic film is preferred to protect the goods

3.9 ¼ Displays and Dollies

Displays below 25kg can be delivered on ¼ CHEP pallets alternately to dollies. ¼ CHEP pallets have to be delivered on a CHEP or Europallet in a quantity of four (if an appropriate amount is ordered). A ¼ display below 25 kg without dolly or ¼ CHEP will be charged with EUR 10,- per display.

A delivery on half pallets is not accepted. ½ displays have to be delivered on rollies from CONTAINER CENTRALEN. For each delivery of a ½ display without a rollie the supplier will be charged € 10,- per display.

If the display has no correct barcode the supplier will be charged € 5,- per display.

Contact Information:

CHEP Österreich GmbH	HB RTS D.A.CH GmbH
Mariahilferstrasse 123/3 A-1060 Wien Telefon: +43 (0) 1 59999 448	Dreischeibenhaus D-40211 Düsseldorf Telefon: +49 173 493 99 33



¼ Pallet



Dolly

3.10 Dangerous Substances

The regulations of the ADR governing limited amounts (“Consumer packaging”) must be followed.

A summary of the most important points as an extract from the aforementioned regulations:

Dangerous goods counted as limited amounts if they are packaged and labelled according to the ADR:

- Packaging must be composite packaging i.e. numerous internal packages within an external package:
 - numerous inner packaging within an outer packaging: for instance, in a box or
 - numerous internal packaging in trays, combined into a packing unit with stretch (cling) or shrink film (Caution: only with use of inner packaging made out of metal or plastic – not for inner packaging made out of a different material like glass, may a stretch or shrink film be used instead of an outer packaging.)
- The amount limits (dependent upon the dangerous goods transport classification system) may not be exceeded:
 - for the highest allowable material amount per internal packing unit
 - in part, also the highest allowed material amount per transport item
 - in part additionally, for the highest allowed total mass of the transport item (i.e. the total mass of trays may generally not exceed 20 kg in total.)
- The transport items (packets or trays) must be clearly and permanently marked:
 - with the ID number of the contained goods prefixed with the letters “UN”:
 - with various goods with different ID numbers in the same transport item: with the ID numbers of the contained goods prefixed with the letters “UN” or with the letters “LQ”.

This ID marking must be framed by a black line, creating a square balanced on it’s point with a side length of at least 100 mm; if the size of the transport item requires, this label may have smaller dimensions as long as it remains clearly visible.

This labelling must be visible at all times. Therefore, each labelling of transport items must also be affixed to out packaging (i.e. wrap or shrink film for securing stacked items on a pallet) if this makes the direct labelling of the transport items no longer visible.

3.11 Delivery in Reuseable Cases

- SPAR accepts different types of reusable cases (E2 cases and IFCO cases) and deposit packaging. Any introduction of a new reusable case or deposit packaging must be approved by SPAR.
- **BEWARE: SPAR only accepts goods in clean cases!**
- Should the delivery not be in clean cases the following consequences apply:
 1. Goods are not accepted.
 2. If the goods are accepted, the supplier will be charged EUR 0,50/case. Should SPAR be charged for dirty cases, this charge will be passed on to the supplier.
- The collection must be coordinated with the responsible contact persons in the regional warehouse. An agreed collection date must be adhered to and may only be changed with the consent of the regional warehouse.

Labelling

Please send us a sample label (pallet and WPU) prior to the first delivery for testing!

In case you are generating a GS1 barcode for the first time, please contact the GS1 institution of your country, to fulfil all requirements.

Warehouse suppliers to:

SPAR Österr. Warenhandels AG

Zweigniederlassung St. Pölten

Lagergasse 30, 3106 St.Pölten-Spratzern

Thomas Gessner, Tel. +43 2742 866 345325

thomas.gessner@spar.at

Additional Information can be found at <http://www.gs1.at>.

Contact GS1

GS1-Austria

Brahmsplatz 3, 1040 Wien

Gerald Gruber, Tel: +43 1 505 8601 43

E-Mail: gruber@gs1.at

4.1 Pallet Labelling

SPAR requires the labelling of all pallets with the GS1-128+SSCC pallet label.

If the GS1:128 and the SSCC are missing or are encoded falsely, SPAR will charge the supplier EUR 5.5 per pallet.

Data Content:

- SSCC - Number of the pallet AI (00)
- the GTIN-Number of the secondary packaging (Wholesale P U) AI (02)*
- the best before date – if available AI (15)
- the batch number – if available AI (10)
- amount of secondary packaging (WPU) on the pallet AI (37)

*The GS1-128+SSCC label must comprise the WPU GTIN which was agreed on with SPAR. Displaying other GTINs, for example the GTIN Number of the over packaging is not permitted.

Module width / Barcode height:

Width: 0,495 – 1,016 mm

Height: 32 mm

Sticker/Label format (Recommendation):

DIN A5 210 x 148 mm (H x W)

DIN A6 148 x 105 mm (H x W)

4.2 Examples of Delivery Notes (DIN A5)

MUSTERUNTERNEHMEN

LOGO

Straße

Ort

Produktbeschreibung

SSCC: **390123450000000012**

CONTENT
(GTIN der Handelseinheit): **9012345000028**

COUNT
(Menge der Handelseinheiten): **120**

BEST BEFORE
(Mindesthaltbarkeitsdatum): **21.05.2023**

BATCH/LOT
(Los/Charge): **A12345678**

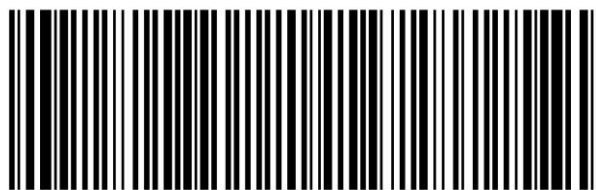

(02)09012345000028(15)230521(37)0120

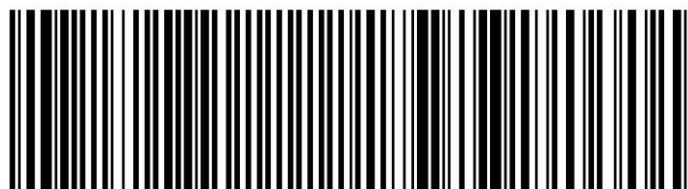

(00)390123450000000012(10)A12345678

4.3 Placement of the pallet labels

- According to the ECR handbook, the GS1 transport-label must be applied 400 - 800mm from the floor and at least 50 mm from the side. On transport secured pallets the sticker must be attached to the plastic film. One label must be applied on the narrow side and one on the long side to the right hand side of it.
- For better processing in our warehouses, we would like to ask you to attach the pallet label as far right as possible. This allows us an optimal handling at every move of the pallet.
- On low pallets it is allowed to bend the text field over the edge onto the top. The barcode part must be scan able without any further manipulation (ECR documentation „Harmonisierung GS1-128 – GS1 Transportetikett“).
- For whole and layer pallets, the pallet label must be applied on the outside of the pallet film. For mixed pallets, the pallet label must be applied on the inside (print side of the label facing forward) of the pallet film.

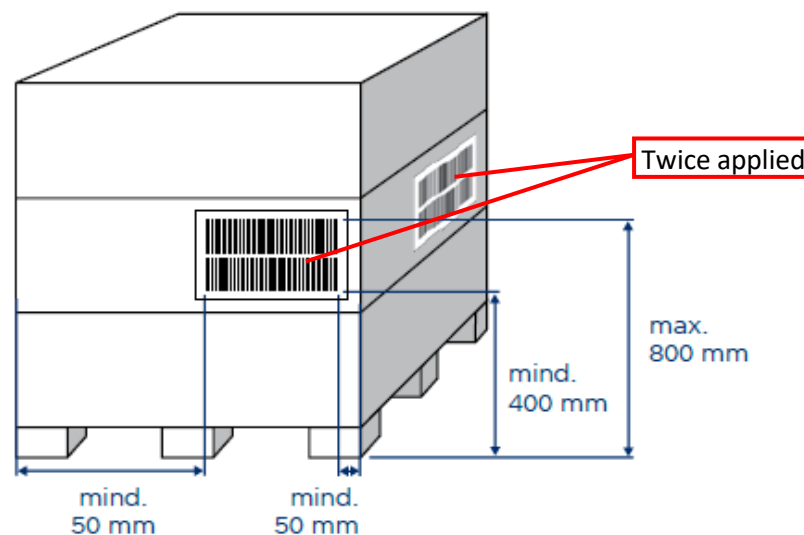

4.4 WPU (Wholesale -Packing-Unit)

Basically, secondary packaging should be labelled with clear text as well as with a barcode (EAN-13, ITF-14, UPC-A, GS1-128 mit GTIN).

The content must be clearly and visibly stated. This facilitates the allocation of the goods to the bill of delivery. The product number, name and the number of single trade PKUs must be displayed.

The labelling must be done according to GS1 standards, on two sides of the packaging.

Should the labelling with EAN-13, ITF-14 or GS1-128 be missing or be encoded falsely, SPAR will charge the supplier a surcharge of EUR 0.40 per unit.

Examples of Labels:





4.5 RPU (Retail Packing Unit)

Labelling with the following barcode is accepted:

- EAN-8
- EAN-13
- UPC-A

Examples of labels:

 9 0 9 9 9 1 2 3	 9 0 1 2 3 4 5 0 0 0 0 1 1 >	 0 1 2 3 4 5 6 7 8 9 1 2
EAN-8	EAN-13	UPC-A

4.6 Barcode quality

In order to ensure fast and efficient scanning processes at the cash registers and in SPAR wholesale-fulfillment centers, the following quality requirements of the barcodes are needed:

The attached bar code symbol must have at least the following overall symbol class according to **ISO / IEC 15416**:

The attached barcodes must have an overall symbol class of at least **1.5** according to ISO / IEC 15416 (test specification for barcode quality), the barcode must also correspond to the respective specifications of the barcode symbology.

To ensure optimal readability of the barcodes, SPAR recommends an overall symbol **classification of 2.5**.

For your information: A barcode can be rated between 0 and 4 with a test device. According to ISO / IEC 15416 a rating of 4 is the best value. The check can be carried out by an GS1 organization such as GS1 Austria (www.gs1.at/strichcodepruefservice).

Electronic Data Interchange with SPAR

SPAR provides the possibility of interchanging data electronically. The supported messages are orders, Despatch Advice (for warehouses and direct deliveries) and Invoic.

In our Warehouses we set a high value into the DesAdv. This electronic message enables precise planning and processing at the goods receiving and thus accelerates the process. This results in shorter waiting times.

Therefore, we expect our partners to transmit electronic bills of deliveries which accord to todays standards.

BEWARE! In order to use DesAdv's, the correct use of the GS1-128 label on the pallets is absolutely necessary.

Information on the composition of Despatch Advices can be found on our B2B Portal using the following [Link](#) or by accessing threwh the B2B-portal (<http://b2b.spar.at>).

In the Warehouses we require the hierarchical DesAdv incl. SSCC.

If the transferred data (expiry date, quantity and batch) from the DesAdv is not correct or the whole DesAdv is missing, SPAR charges the additional expenses of EUR 100,-.

Safety measurements at Goods Receiving

Warehouse Premises

- Driving with an open auto hoist on SPAR warehouse premises is forbidden.
- The road transport regulation is applicable on warehouse premises, with a maximum speed of 10 km/h and keeping to the right. Please beware of human traffic.
- The parking of vehicles is only permitted in the designated areas and only until unloading.

Goods receiving

- Follow the instructions of the goods receiving personnel.
- Access is only granted to the goods receiving area. All other areas of the warehouse may only be accessed when permitted.
- Before unloading the supplier has to register with the responsible goods receiving and show bill of lading and bill of delivery.
- The automatic lifting ramps are to be operated accordingly. Should the truck driver have no experience with these he must announce this to the SPAR personnel who will brief him.
- The unloading has to be carried out by the supplier.
- The unloading is only permitted with safety shoes.
- Should the pallet quality not comply with the standards of SPAR, the pallet will not be exchanged.



Safety measurements at Goods Receiving

General

- The handling of SPAR owned electronic devices takes place at the users' risk. The supplier is liable for all damage occurred. Accidents and damage are to be announced to the goods receiving supervisor immediately and a report of the accident has to be written.
- All waste has to be removed accordingly.
- Smoking in the hall and the drinking of alcoholic beverages everywhere on the warehouse premises are strictly forbidden.
- Beware of frequent traffic with electronic devices at goods receiving.
- In case of a fire alarm, obey the instructions of SPAR personnel.
- Emergency exits have to be free at every time.

